

305 Distribution Amplifier (1x4)

Table of Contents

<i>Chapter 1</i>	Introduction	1
<i>Chapter 2</i>	Operator Safety Summary	2
<i>Chapter 3</i>	Fast Setup	3
<i>Chapter 4</i>	Front Panel Overview	4
<i>Chapter 5</i>	Rear Panel Overview	5
<i>Chapter 6</i>	Connecting to Other Gear	7
<i>Chapter 7</i>	Signal Flow Chart	10
<i>Chapter 8</i>	Troubleshooting	11
<i>Chapter 9</i>	Specifications	12
<i>Chapter 10</i>	Warranty and Service	13
<i>Chapter 11</i>	Declaration of Conformity	15

Rev A, 15 June, 1998

Symetrix part number 53305-0A00

Subject to change at our whim and fancy without notice.

©1998, Symetrix, Inc. All right reserved.

Symetrix is a registered trademark of Symetrix, Inc.

Mention of third-party products is for informational purposes only and constitutes neither an endorsement nor a recommendation. Symetrix assumes no responsibility with regard to the performance or use of these products.

Under copyright laws, no part of this manual may be reproduced or transmitted in any form or by any means, electronic or mechanical, including photocopying, scanning, recording or by any information storage and retrieval system, without permission, in writing, from Symetrix, Inc.

 **Symetrix**
6408 216th St. SW
Mountlake Terrace, WA 98043 USA
Tel (425) 778-7728
Fax (425) 778-7727
Email: symetrix@symetrixaudio.com

305

Congratulations on your purchase of the Symetrix 305 Distribution Amplifier (1x4). The 305 accepts one balanced input signal and distributes it to four independent outputs. The volume of the input may be controlled via a front panel trimpot, as can the volume of each individual output.

Distribution amplifiers are generally used to split one signal into multiple isolated sends. For example, a sound reinforcement engineer may wish to supply the mixer's mono output signal to the house sound system, to a backstage cueing system, to a DAT recorder and to a media feed. The Symetrix 305 fits the bill nicely, supplying four separate, isolated outputs. In the event that one of the outputs shorts (for example, the TV camera operator inadvertently plugs a shorted cord into the media feed), the other three outputs continue to supply signal, unaffected by the short circuit. The outputs are also isolated to protect against ground hum problems.

The 305's input level control allows the sound engineer to adjust the 305's input level properly for the amount of signal being fed to it from the mixer's output. The individual output level trimpots allow each of the four output levels to be tailored to their application. For example, an output that is being fed to the input of a DAT recorder may be adjusted to provide a signal level that optimizes recording resolution without overloading the input of the DAT recorder.

The Symetrix 305 also offers a four-LED input level meter, to assist the user in setting optimum operating levels. The balanced input stage is designed for high common mode rejection and RF immunity. Output line drivers are stable, short-circuit protected, and designed around industry standard 5532-type op amps.

The Symetrix 305 offers high-quality, low-noise audio distribution with convenient and desirable features, all at a modest price. Only minimal space in your equipment rack is needed to contain this powerhouse unit.

We recommend that you read this manual cover-to-cover. You will find the answers to most of your questions inside. However, if you are in a hurry, go directly to Chapter 3 (Fast Setup). It will get you started quickly. Please feel free to contact us if you have questions, comments or suggestions.

- Phone: (425)778-7728
- Fax: (425)778-7727
- Email: symetrix@symetrixaudio.com
- Website: www.symetrixaudio.com

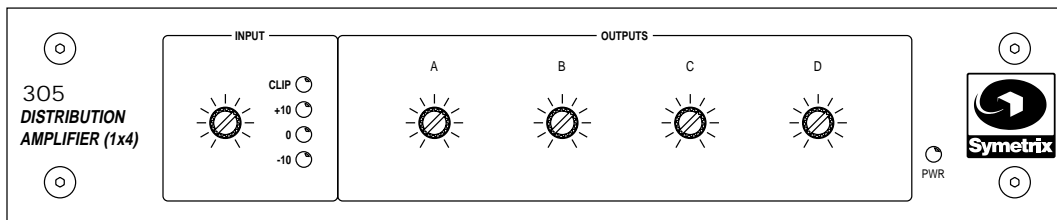

Front panel

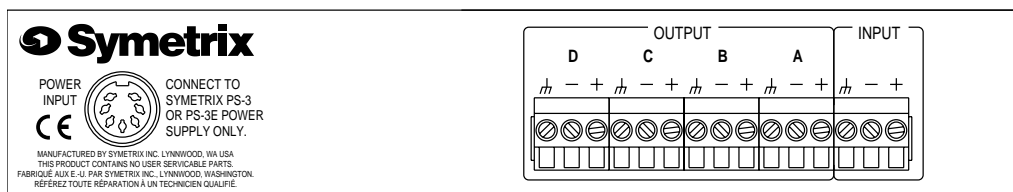

Rear panel



The information in this summary is intended for persons who operate the equipment as well as repair personnel. Specific warnings and cautions are found throughout this manual wherever they may apply.

The notational conventions used in this manual and on the equipment itself are described in the following paragraphs.

Equipment Markings

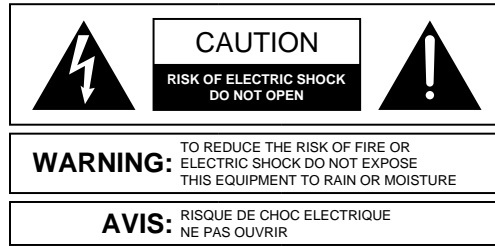

SEE OWNERS MANUAL. VOIR CAHIER D'INSTRUCTIONS.
No user serviceable parts inside. Refer servicing to qualified service personnel.
Il ne se trouve a l'interieur aucune piece pouvant entre reparaee l'usager.
S'adresser a un reparateur competent.

The lightning flash with arrowhead symbol within an equilateral triangle is intended to alert the user of the presence of uninsulated dangerous voltage within the product's enclosure that may be of sufficient magnitude to constitute a risk of electric shock to persons.

The exclamation point within an equilateral triangle is intended to alert the user of the presence of important operating and maintenance (servicing) instructions in the literature accompanying the 305 (i.e. this manual).

Caution *To prevent electric shock, do not use the polarized plug supplied with the 305 with any extension cord, receptacle, or other outlet unless the blades can be fully inserted.*

Terms

Several notational conventions are used in this manual. Some paragraphs may use Note, **Caution**, or **Warning** as a heading. Certain typefaces and capitalization are used to identify certain words. These are:

Note Identifies information that needs extra emphasis. A Note generally supplies extra information to help you to better use the 305.

Caution Identifies information that, if not heeded, may cause damage to the 305 or other equipment in your system.

Warning Identifies information that, if ignored, may be hazardous to your health or that of others.

CAPITALS Controls, switches or other markings on the 305's chassis.

Boldface Strong emphasis.

Power source - This product is intended to operate from a power source that does not apply more than 255Vrms between the power supply conductors or between either power supply conductor and ground. A protective ground connection, by way of the grounding conductor in the power cord, is essential for safe operation.

Danger from loss of ground - If the protective ground connection is lost, all accessible conductive parts, including knobs and controls that may appear to be insulated, can render an electric shock.

In-line power supply - This product receives its operating power from the Symetrix PS-3 or PS-3E power supply. This is the only power supply approved for use with the product. Do not connect the product to any other in-line, or plug-in, transformer. The use of other power sources may cause damage to the equipment or present a shock hazard to the operator.

Operating location - Do not operate this equipment under any of the following conditions: explosive atmospheres, in wet locations, in inclement weather, improper or unknown AC mains voltage, or if improperly fused.

Stay out of the box - To avoid personal injury or injury to others, do not remove the product covers or panels. Do not operate the product without the covers and panels properly installed.

305

Fast First-Time Setup

Follow these instructions to get your 305 up-and-running as quickly as possible. The intent of this section is fast setup. Refer to later chapters for explanation of the 305's controls and functions.

1. Connect audio inputs and outputs. If you do not know how to do this, forget Fast Set-Up and read Chapter 5.
2. Set INPUT level trim control straight up (12 o'clock position).
3. Set OUTPUT level trim controls at maximum level (clockwise rotation).
4. Plug the 305 into an AC outlet using the external power supply.

Caution: *Failure to connect the 305 to the proper AC mains voltage may cause fire and/or internal damage.*

Warning: **Lethal voltages are present inside the chassis. There are no user serviceable parts inside the chassis. Refer all service to qualified service personnel or to the factory.**

5. Apply line level audio signal to the input. Line level means previously amplified audio, i.e. not the output of a microphone or other unamplified audio transducer.
6. Turn up the INPUT level pot until the red CLIP LED just barely lights. Then back the level down just a bit until the CLIP LED doesn't come on any more, or only occasionally flashes.
7. Now read the rest of this user's guide.

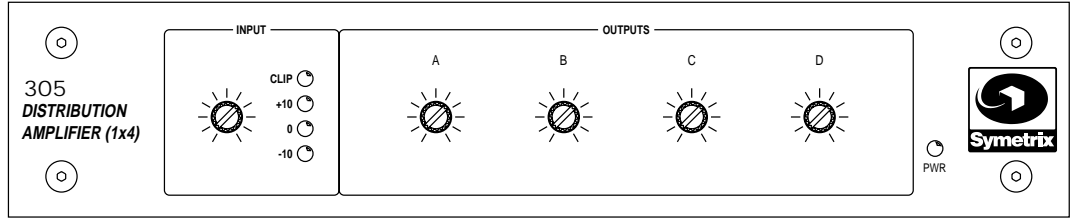

Front panel drawing

Input Level Controls

The input level control on the 305 is marked INPUT. This control adjusts its corresponding input signal over a 30dB range. With signal applied to input, turn up the INPUT level pot until the red CLIP LED just barely lights. Then back the level down just a bit until the CLIP LED doesn't come on any more, or only occasionally flashes. This is the optimum setting and will provide the greatest signal-to-noise ratio without distortion.

If your incoming signal position is unpredictable then we suggest a straight up (12 o'clock) setting. Since the 305's input has 18dB of headroom above +4dBu, this setting should work well under most conditions.

Note If you wish to even out the variances in signal level, we recommend processing your signal with the Symetrix 421m Automatic Leveler before it reaches the 305.

If you find that your input signal is very low (the output of a -10 consumer level device, such as a CD player, for example), turn the INPUT level control clockwise to boost the signal. Conversely, if you're feeding a +8 broadcast level signal to the 305 then turn the INPUT level control counterclockwise until the proper LED display is achieved.

Output Level Controls

The four output level controls on the 305 are in the section marked OUTPUT and are labeled A, B, C, and D. Use these controls to attenuate the output level over a 20dB range. Start by turning all controls fully clockwise (unity gain). This will create equal levels from all outputs. If for some reason you wish to reduce the level of certain outputs then turn the appropriate control(s) counterclockwise. Otherwise, for better overall system performance, it's best to leave the controls wide open (full clockwise) for the hottest possible output signals.

305

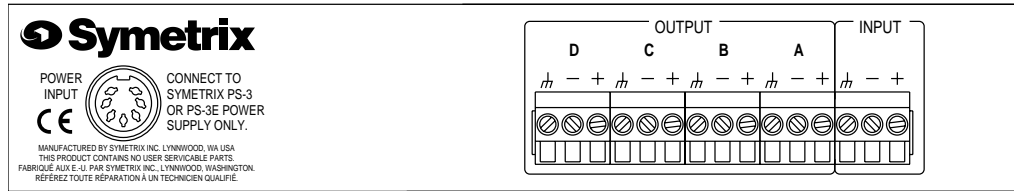

Rear panel drawing

The 305 is fitted with removable terminal blocks for both input and output connections. While not absolutely necessary, it is usually much easier to unplug the removable block before making or changing connections.

INPUT

The 305's input is balanced. Of course, it may be used in unbalanced configurations, but for optimum system wide performance (best noise rejection) balanced operation is highly recommended whenever possible. Be sure to use shielded cable for both input and output connections. The wire should always be two-conductor plus shield, even for unbalanced connections.

For a balanced input signal:

1. Connect the incoming signal + (high) to the + INPUT terminal of the 305.
2. Connect the incoming signal - (low) to the - INPUT terminal of the 305.
3. Connect the incoming signal ground (shield) to the ground terminal of the 305. Repeat for all inputs.

For an unbalanced input signal, using two-conductor shielded cables:

1. Connect the incoming signal + (high) to the + INPUT terminal of the 305. Use the red wire.
2. Connect the incoming signal ground to the - INPUT terminal of the 305. Use the black wire.
3. Connect the cable shield at the ground connection of the 305 only.

If you experience hum or noise, make sure that both the 305 and the device which you are feeding to the 305's input are grounded on the same AC mains circuit. If this is not the source of the noise problem, you must isolate the unbalanced output from the balanced input with an audio transformer or matchbox.

If the unbalanced output of the device preceding the 305 is -10dBV (semi-pro or consumer level), the Symetrix 303 Interface Amplifier is an excellent choice for isolation. Not only will the 303 convert the unbalanced signal to an isolated balanced signal, it will also boost the -10dBV signal to the +4dBu level at which the 305 was designed to operate.

OUTPUTS

The 305's output is an active balanced circuit and should be used to feed balanced audio inputs. Use two-conductor shielded audio cable for all connections.

Feeding balanced inputs:

1. Connect the + (high) OUTPUT terminal of the 305 to the + (high) of the input of the device which you are feeding.
2. Connect the - (low) OUTPUT terminal of the 305 to the - (low) of the input of the device which you are feeding.
3. Connect cable shield to the ground of the 305 and the ground connection of the device which you are feeding.



Feeding unbalanced inputs:

WE DON'T RECOMMEND IT. If you must feed an unbalanced input with the 305, you should isolate the two devices with either an audio transformer or an interface matching device (a matchbox). The 305 follows the AES standards for balanced audio circuits. The ground connections of the amplifier are chassis ground.

If you must connect the output of the 305 directly to an unbalanced input, try this procedure. Use two-conductor shielded audio cable.

1. Connect the + (high) OUTPUT terminal of the 305 to the + (high) of the unbalanced input.
2. Make no connection to the - (low) OUTPUT terminal of the 305.
3. Connect the cable shield at the 305's ground and at the input connector of the unbalanced input.

The output signal level of the 305 will be 6 dB lower when driving an unbalanced input without a transformer or matching interface device.

If you experience hum or noise, make sure that both the 305 and the device which you are feeding are grounded on the same AC mains circuit. If this is not the source of the noise problem, you must isolate the balanced output from the unbalanced input with an audio transformer or matchbox.

305

Matching Levels vs Matching Impedances

In any audio equipment application, the question of matching inevitably comes up. Without digging a hole any deeper than absolutely necessary, we offer the following discussion to (hopefully) clarify your understanding of the subject.

Over the years, we have all had impedance matching pounded into our heads. This is important only for vintage audio systems, power amplifiers, and RF. Technically speaking, the reason is power transfer, which reaches a maximum when source and load are matched. Modern audio systems are voltage transmission systems and source and load matching is not only unnecessary, but undesirable as well.

- ❑ Vintage audio systems operate at 600 ohms (or some other impedance value), and must be matched, both at their inputs and at their outputs. Generally speaking, if you are dealing with equipment that uses vacuum tubes, or was designed prior to 1970, you should be concerned about matching. These units were designed when audio systems were based on maximum power transfer, hence the need for input/output matching.
- ❑ Power amplifiers are fussy because an abnormally low load impedance generally means a visit to the amp hospital. Thus, it is important to know what the total impedance of the pile of speakers connected to the amplifier really is.
- ❑ RF systems are matched because we really are concerned with maximum power transfer and with matching the impedance of the transmission line (keeps nasty things from happening). Video signals (composite, baseband, or otherwise) should be treated like RF.

Some folks seem to believe that balanced/unbalanced lines and impedances are related; or even worse that they are associated with a particular type of connector. **Not so.** Unbalanced signals are not necessarily high-impedance and balanced signals/lines are not necessarily low-impedance. Similarly, although 1/4 inch jacks are typically used for things like guitars (which are high-impedance and unbalanced), this does not predispose them to this use alone. After all, 1/4 inch jacks are sometimes used for loudspeakers, which are anything but high-impedance. Therefore, the presence of 3-pin XLR connectors should not be construed to mean that the input or output is low-impedance (or high-impedance). The same applies to 1/4 inch jacks.

So, what is really important? Signal level, and (to a much lesser degree), the impedance relation between an output (signal source) and the input that it connects to (signal receiver).

Signal level is very important. Mismatch causes either loss of headroom or loss of signal-to-noise ratio. Thus, microphone inputs should only see signals originating from a microphone, a direct (DI) box, or an output designated microphone-level output. Electrically, this is in the range of approximately -70 to -20 dBm. Line inputs should only see signals in the -10 to +24 dBm/dBu range. Guitars, high-impedance microphones, and many electronic keyboards do not qualify as line-level sources.

The impedance relation between outputs and inputs needs to be considered, but only in the following way - *Always make sure that a device's input impedance is higher than the output source impedance of the device that drives it.*

Some manufacturers state a relatively high-impedance figure as the output impedance of their equipment. What they really mean is that this is the minimum load impedance that they would like their gear to see. In most cases, seeing a output impedance figure of 10,000 (10K) ohms or higher from modern equipment that requires power (batteries or AC) is an instance of this type of rating. If so, then the input impedance of the succeeding input must be equal to or greater than the output impedance of the driving device.

Symetrix equipment inputs are designed to bridge the output of whatever device drives the input (i.e. to be greater than 10 times the actual source impedance). Symetrix equipment outputs are designed to drive 600-ohm or higher loads (600-ohm loads are an archaic practice that won't go away). You don't need to terminate the output with a 600-ohm resistor if you aren't driving a 600-ohm load. (If you don't understand the concept of termination, you probably don't need to anyway.)



The two facts that you need to derive from this discussion are:

- Match signal levels for best headroom and signal-to-noise ratio.
- For audio, impedance matching is only needed for vintage equipment and power amplifier outputs. In all other cases, ensure that your inputs bridge your outputs (meaning the inputs are in the range of 2 to 200 times the output source impedance).

Signal Levels

The 305 is designed around studio/professional line levels: +4 dBu or 1.23 volts RMS. The unit is quiet enough to operate at lower signal levels such as those found in semi-pro or musical instrument (MI) equipment (-10 dBv or 300 millivolts).

I/O Impedances

The 305 is designed to interface into almost any recording studio or sound reinforcement application. This includes:

- 600-ohm systems where input and output impedances are matched.
- Modern bridging systems where inputs bridge and outputs are low source impedances (voltage transmission systems).

The 305's input impedance is 20-kilohms balanced. The inputs may be driven from any balanced source capable of delivering at least -10 dBv into the aforementioned impedances.

The 305's output impedance is 200 ohms balanced, 100 ohms unbalanced. The output line driver delivers +22 dBu into 600-ohm balanced loads or +18 dBm into 600-ohm unbalanced loads.

Input and Output Connections

The illustration on the next page shows how to connect the 305 to balanced and unbalanced sources and loads. Please remember that unbalanced operation is not recommended.

If you must operate the 305 from unbalanced sources, run a 2-conductor shielded cable (that's two conductors plus the shield) from the source to the 305. At the source, connect the cable connector's sleeve to one conductor (this will be the - or the low conductor) and connect the tip to the remaining + or high conductor, leaving the shield unconnected. Connect the shield to the chassis connection and the cable's - and + to the corresponding 305 input connection.

This is the preferred method as it makes best use of the 305's balanced input (even though the source is unbalanced). An alternative shown in the illustration converts the 305's balanced input into an unbalanced input at the input connector. This works, but is more susceptible to hum and buzz than the preferred method. There is no level difference between methods.

You can drive unbalanced loads with the 305's outputs by using the XLR connector with pin 3 left open. In an emergency (the show must go on), you can ground pin 3, but if you have the choice...leave it open. If you must ground pin 3, it must be grounded at the 305, rather than at the other end of the cable. The price, regardless of whether or not pin 3 is grounded is 6 dB less output level. If your system is wired with pin 3 hot, and you are driving an unbalanced load, **pin 2 must float**.

305

Balanced Terminal Strip

(When Using CIRCUIT Ground)
(Wire Shield Not Connected)

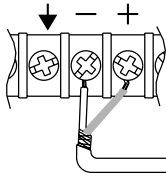

Two Conductor
Shielded Cable

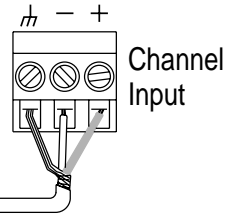

Balanced Female XLR

(When Using CIRCUIT Ground)

Pin 1=Not Connected

Pin 2 = High

Pin 3 = Low

Shield Tab = Not Connected

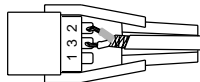

Two Conductor
Shielded Cable

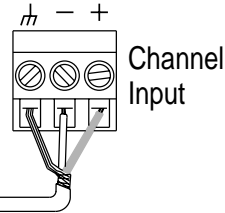

TRS Plug

(When Using CIRCUIT Ground)

Tip = High

Ring = Low

Sleeve = Not Connected

(Wire Shield Not Connected)

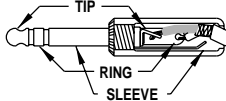

Two Conductor
Shielded Cable

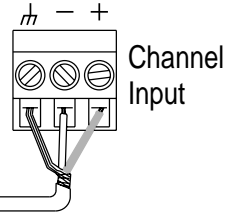

TS Plug

(When Using CIRCUIT Ground)

Tip = High

Sleeve = Low

(Wire Shield Not Connected)

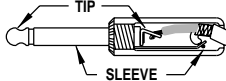

Two Conductor
Shielded Cable

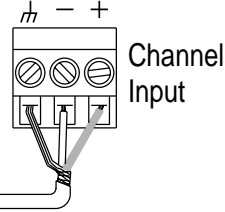

RCA Plug

(When Using CIRCUIT Ground)

Tip = High

Sleeve = Low

(Wire Shield Not Connected)

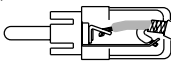

Two Conductor
Shielded Cable

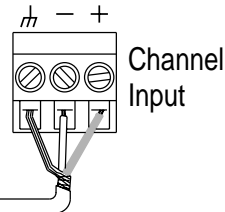

Balanced Male XLR

(When Using CIRCUIT Ground)

Pin 1= Circuit Ground

Pin 2 = High

Pin 3 = Low

Shield Tab = Not Connected

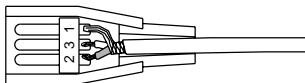

Two Conductor
Shielded Cable

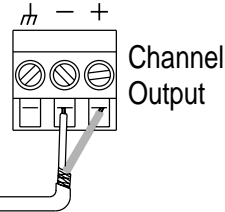

TS Plug

(When Using CIRCUIT Ground)

Tip = High

Sleeve = Shield

(Wire Low Not Connected)

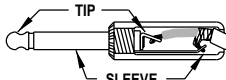

Two Conductor
Shielded Cable

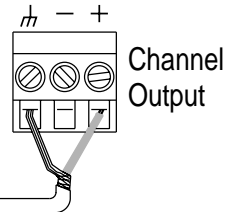

305

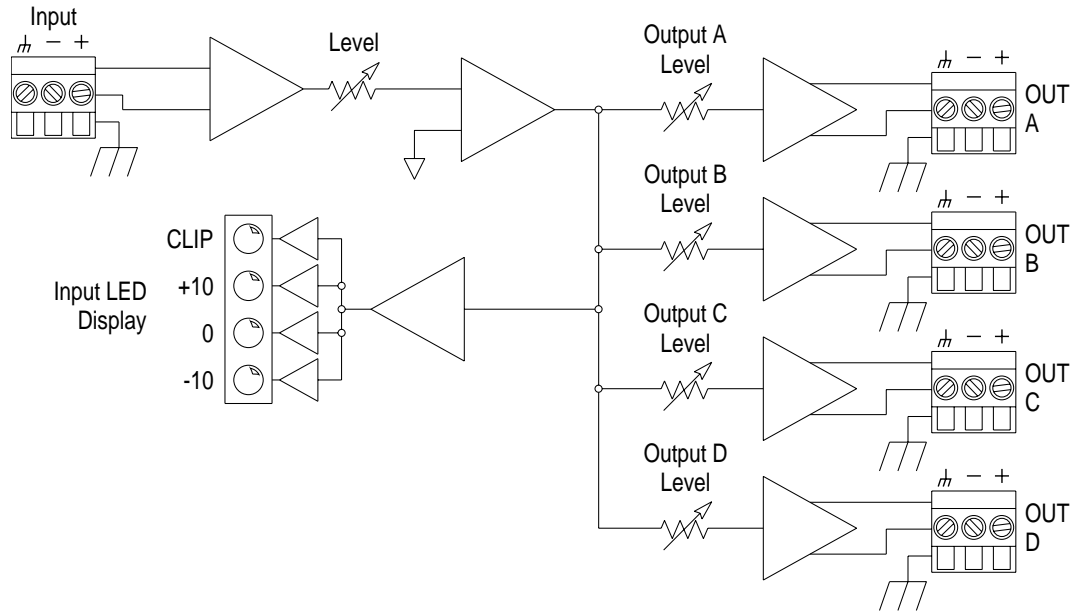

305

Troubleshooting Chart

<u>SYMPTOM</u>	<u>PROBABLE CAUSE</u>
No output signal	Check cables and connections. Is the input driven by an output, and output driving input? Verify cables, source and load by patching input and output connections together, at the unit. Check for AC power presence.
Hum or buzz in output	Check input and output connector wiring (refer to page 9). Ground loop: check related system equipment grounding. Are all system components on the same AC ground?
Distortion	Check the level of the input signal on the 305's LED display. Is the CLIP light on all the time? If so, reduce the incoming signal level by turning the INPUT level counterclockwise. Is the incoming signal already distorted? Listen up stream from the 305 to make sure you re feeding it a clean signal.
Noise (hiss)	Check input signal level and input level control settings. The input signal may be too low. If so, boost the incoming signal (if possible). Is the input signal already noisy? Listen up stream from the 305 to determine that you are feeding it a clean signal. Verify that all system components on the same AC ground.
No LED display	Is the unit plugged in, and turned on? Is the AC outlet OK? Is a signal of at least -10dB being fed to the input of the 305?

305

Architects and Engineers Specifications

The Symetrix 305 Distribution Amplifier shall be a one channel audio distribution amplifier consisting of one electronically balanced input amplifier and four electronically balanced output amplifiers. There shall be a master gain adjustment circuit capable of up to 15dB of gain or 15dB of loss for the purpose of optimally matching incoming signal level(s). There shall be a four-LED array for the indication of the signal level applied to the output drive circuits. The LED s shall be labelled CLIP, +10, 0, and -10 corresponding to internal signal levels of +18dBu, +10dBu, 0dBu, and -10dBu.

The output shall be capable of driving a 600-ohm balanced load to a level of +22 dBu. The maximum output level into a balanced bridging load (20K Ohms) shall be +26 dBu. The output will offer an individual attenuator with a range of 0 to -20 dB.

Frequency response through the amplifier shall be $\pm 1/2$ dB, measured between 20 Hz and 20 kHz. THD+Noise shall be less than 0.009% measured at +26dBu with a band-

width of 30 kHz. Residual noise will be >100 dB below a +4 dBu input signal when measured with an A-weighting filter.

The unit shall occupy half of the width of one rack space. The physical dimensions shall be 1.75"H x 8.5"W x 6.5"D; 4.445cm H x 21.59cm W x 15.875cm D.

The distribution amplifier shall operate by means of a Symetrix PS-3 or PS-3E power supply connected to 117V AC nominal, (95-130V AC), 50-60 Hz or 230V AC nominal, (165-255V AC), 50 Hz.

The distribution amplifier shall be a Symetrix, Inc. model 305 Distribution Amplifier (1x4).

Specifications

Input/Output	
Maximum Input Level	+26 dBu Balanced
Maximum Output Level	+26 dBu Balanced (20k Ohm load) +22 dBu (600 Ohm load)
Input Impedance	20k Ohms Balanced, 10k Ohms Unbalanced
Output Impedance	200 Ohms Balanced, 100 Ohms Unbalanced

Performance Data	
Frequency Response	$\pm 1/2$ dB, 20 Hz to 20 kHz
THD+Noise	<.009% at +26dBu, 30kHz measurement bandwidth
Signal to Noise Ratio	>100dB, A-weighted, ref. to +4dBu
Dynamic Range	>125 dB, A-weighted
Common Mode Rejection	>40 dB, 20 Hz to 20 kHz
Input Gain Range	± 15 dB
Output Gain Range	0 to -20dB

Physical	
Size (hwd)	1.75 x 8.5 x 6.5 in., 4.445 x 21.59 x 15.875 cm.
Shipping Weight	4.5 lbs

Electrical	
Power Requirements	117V AC nominal, 95-130V AC, 50 to 60 Hz 230V AC nominal, 165-255V AC, 50Hz

In the interest of continuous product improvement, Symetrix, Inc. reserves the right to alter, change, or modify these specifications without prior notice.
© 1998, Symetrix, Inc. All rights reserved.

305



305 Limited Warranty

Symetrix, Inc. expressly warrants that the product will be free from defects in material and workmanship for (18) months. Symetrix's obligations under this warranty will be limited to repairing or replacing, at Symetrix's option, the part or parts of the product which prove defective in material or workmanship within (18) months from date of shipment, provided that the Buyer gives Symetrix prompt notice of any defect or failure and satisfactory proof thereof. Products may be returned by Buyer only after a Return Authorization number (RA) has been obtained from Symetrix. Buyer will prepay all freight charges to return the product to the Symetrix factory. Symetrix reserves the right to inspect any products which may be the subject of any warranty claim before repair or replacement is carried out. Symetrix may, at its option, require proof of the original date of purchase (dated copy of original retail dealer's invoice). Final determination of warranty coverage lies solely with Symetrix. Products repaired under warranty will be returned freight prepaid by Symetrix via United Parcel Service (surface), to any location within the Continental United States. At Buyer's request the shipment may be returned via airfreight at Buyer's expense. Outside the Continental United States, products will be returned freight collect.

The foregoing warranties are in lieu of all other warranties, whether oral, written, express, implied or statutory. Symetrix, Inc.

Limitation of Liability

The total liability of Symetrix on any claim, whether in contract, tort (including negligence) or otherwise arising out of, connected with, or resulting from the manufacture, sale, delivery, resale, repair, replacement or use of any product will not exceed the price allocable to the product or any part thereof which gives rise to the claim. In no event will Symetrix be liable for any incident

expressly disclaims any IMPLIED warranties, including fitness for a particular purpose or merchantability. Symetrix's warranty obligation and buyer's remedies hereunder are SOLELY and exclusively as stated herein.

This Symetrix product is designed and manufactured for use in professional and studio audio systems and is not intended for other usage. With respect to products purchased by consumers for personal, family, or household use, Symetrix **expressly disclaims all implied warranties, including but not limited to warranties of merchantability and fitness for a particular purpose.**

This limited warranty, with all terms, conditions and disclaimers set forth herein, shall extend to the original purchaser and anyone who purchases the product within the specified warranty period.

Symetrix does not authorize any third party, including any dealer or sales representative, to assume any liability or make any additional warranties or representation regarding this product information on behalf of Symetrix.

This limited warranty gives the buyer certain rights. You may have additional rights provided by applicable law.

tal or consequential damages including but not limited to damage for loss of revenue, cost of capital, claims of customers for service interruptions or failure to supply, and costs and expenses incurred in connection with labor, overhead, transportation, installation or removal of products or substitute facilities or supply houses.

305

Servicing the 305

If you have determined that your 305 requires repair services and you live *outside* of the United States, please contact your local Symetrix dealer or distributor for instructions on how to obtain service. If you reside in the U.S. then proceed as follows:

Before sending anything to Symetrix, contact our Customer Service Department for a return authorization (RA) number. The telephone number is (425) 778-7728 or email: tech@symetrixaudio.com

In-warranty Repairs

To get your 305 repaired under the terms of the warranty:

1. Call us for an RA number.
2. Pack the unit in its original packaging materials.
3. Include your name, address, daytime telephone number, and a brief statement of the problem.
4. Write the RA number on the outside of the box.
5. Ship the unit to Symetrix, freight prepaid.

We do not accept freight collect shipments.

Repairs made in-warranty will cost you only one-way freight charges. We'll prepay the return (surface) freight.

If you send us your product in substandard packaging, we will charge you for factory shipping materials. If you don't have the factory packaging materials, please use an oversized carton, wrap the unit in a plastic bag, and surround it with bubble-wrap. Pack the box full of Styrofoam peanuts. Be sure there is enough clearance in the carton to protect the rack ears (you wouldn't believe how many units are returned with bent ears). We will return the unit in Symetrix packaging. Of course, if the repair is due to operator error, parts and labor will be charged. In any event, if there are charges for the repair costs, you will pay for the return freight. All charges will be COD unless you have made other arrangements (prepaid, Visa or Mastercard).

Out-of-warranty Repairs

If the warranty period has passed, you'll be billed for all necessary parts, labor, packaging materials, and freight charges. Please remember, you must call for an RA number before sending the unit to Symetrix.

305

Declaration of Conformity

We, **Symetrix Incorporated**,
6408 216th St. SW, Mountlake Terrace, Washington, USA,
declare under our sole responsibility that the product:

305 Distribution Amplifier (1x4)

to which this declaration relates,
is in conformity with the following standards:

EN 60065

Safety requirements for mains operated electronic and related apparatus for household and similar general use.

EN 50081-1

**Electromagnetic compatibility - Generic emission standard
Part 1: Residential, commercial, and light industry.**

EN 50082-1

**Electromagnetic compatibility - Generic immunity standard
Part 1: Residential, commercial, and light industry.**

The technical construction file is maintained at:

Symetrix, Inc.

6408 216th St. SW
Mountlake Terrace, WA, 98043
USA

The authorized representative located within the European Community is:

World Marketing Associates

P.O. Box 100
St. Austell, Cornwall, PL26 6YU, U.K.

Date of issue: June 15, 1998

Place of issue: Mountlake Terrace, Washington, USA

Authorized signature:



Dane Butcher, President, **Symetrix Incorporated**.

305

 **Symetrix**

305

 **Symetrix**

305

 **Symetrix**



Symetrix, Inc.

6408 216th St. SW
Mountlake Terrace, WA, 98043
USA

Tel: (425) 778-7728

Fax: (425) 778-7727

Website: <http://www.symetrixaudio.com>

Email: symetrix@symetrixaudio.com